

# Micropower Dual/Quad Precision Rail-to-Rail Input and Output Op Amps

## FEATURES

- Rail-to-Rail Input and Output
- Low Supply Current: 75µA Max
- 390µV  $V_{OS(MAX)}$  for  $V_{CM} = V^-$  to  $V^+$
- High Common Mode Rejection Ratio: 83dB Min
- High  $A_{VOL}$ : 400V/mV Min
- Wide Supply Range: 2V to  $\pm 5V$
- Low Input Bias Current: 6nA Typ
- 120kHz Gain Bandwidth Product

## APPLICATIONS

- Supply Current Sensing
- Driving A/D Converters
- Test Equipment Amplifiers

## DESCRIPTION

The LT<sup>®</sup>1466L/LT1467L are dual/quad bipolar op amps that combine rail-to-rail input and output operation with precision specifications. Using a patented technique, both input stages of the LT1466L/LT1467L are trimmed: one at the negative supply and the other at the positive supply. The resulting common mode rejection of 83dB minimum is much better than other rail-to-rail input op amps. A minimum open-loop gain of 400V/mV into a 10k load virtually eliminates all gain error. Operation is specified for 3V, 5V and  $\pm 5V$  supplies.

Unlike other rail-to-rail amplifiers, the input offset voltage of 390µV maximum is guaranteed across the entire rail-to-rail input range, not just at half supply. The graph below contrasts the  $V_{OS}$  specifications of the LT1466L/LT1467L to a competitive part that is specified only at half supply. As can be seen, the LT1466L/LT1467L's limits are much tighter for inputs near either supply.

The LT1466L is available in 8-lead PDIP and SO-8 packages with the standard dual pinout. The LT1467L features the standard quad pinout and is available in a 16-lead narrow SO package.

LT, LTC and LT are registered trademarks of Linear Technology Corporation.

## TYPICAL APPLICATION

Variable Current Source

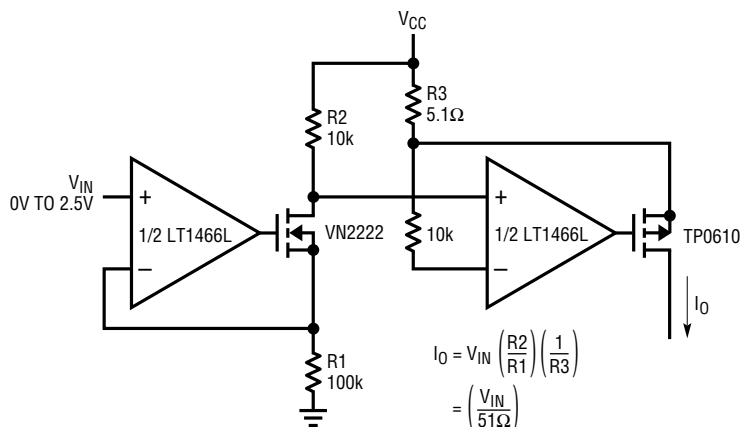

1466L/67L TA01

Worst-Case  $V_{OS}$  vs Input Common Mode Voltage

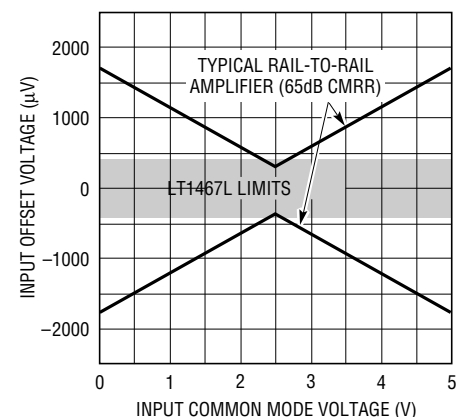

1466L/67L TA02

## ABSOLUTE MAXIMUM RATINGS

Supply Voltage .....  $\pm 8V$   
 Input Current .....  $\pm 15mA$   
 Output Short-Circuit Duration (Note 1) ..... Continuous  
 Specified Temperature Range .....  $0^{\circ}C$  to  $70^{\circ}C$

Junction Temperature .....  $150^{\circ}C$   
 Storage Temperature Range .....  $-65^{\circ}C$  to  $150^{\circ}C$   
 Lead Temperature (Soldering, 10 sec) .....  $300^{\circ}C$

## PACKAGE/ORDER INFORMATION

<p>N8 PACKAGE 8-LEAD PDIP</p> <p>S8 PACKAGE 8-LEAD PLASTIC SO</p> <p><math>T_{JMAX} = 150^{\circ}C</math>, <math>\theta_{JA} = 130^{\circ}C/W</math> (N)  <math>T_{JMAX} = 150^{\circ}C</math>, <math>\theta_{JA} = 190^{\circ}C/W</math> (S)</p>	ORDER PART NUMBER	<p>S PACKAGE 16-LEAD PLASTIC SO</p> <p><math>T_{JMAX} = 150^{\circ}C</math>, <math>\theta_{JA} = 150^{\circ}C/W</math></p>	ORDER PART NUMBER
	LT1466LCN8 LT1466LCS8		LT1467LCS
	S8 PART MARKING		
	1466L		

Consult factory for Industrial and Military grade parts.

## ELECTRICAL CHARACTERISTICS

$T_A = 25^{\circ}C$ ,  $V_S = 5V$ ,  $0V$ ;  $V_S = 3V$ ,  $0V$ ;  $V_{CM} = V_O =$  half supply, unless otherwise noted.

SYMBOL	PARAMETER	CONDITIONS	MIN	TYP	MAX	UNITS
$V_{OS}$	Input Offset Voltage	$V_{CM} = V^+$		110	390	$\mu V$
		$V_{CM} = V^-$		110	390	$\mu V$
$\Delta V_{OS}$	Input Offset Voltage Shift	$V_{CM} = V^-$ to $V^+$		75	345	$\mu V$
	Input Offset Voltage Match (Channel-to-Channel)	$V_{CM} = V^-, V^+$ (Notes 3, 4)		150	550	$\mu V$
$I_B$	Input Bias Current	$V_{CM} = V^+$		3	14	nA
		$V_{CM} = V^-$	-14	-6		nA
$\Delta I_B$	Input Bias Current Shift	$V_{CM} = V^-$ to $V^+$		9	28	nA
$I_{OS}$	Input Offset Current	$V_{CM} = V^+$		0.6	3.6	nA
		$V_{CM} = V^-$		0.4	3.6	nA
$\Delta I_{OS}$	Input Offset Current Shift	$V_{CM} = V^-$ to $V^+$		0.9	5.1	nA
		Input Bias Current Match (Channel-to-Channel)	$V_{CM} = V^+$ (Note 4) $V_{CM} = V^-$ (Note 4)		0.6	5.1
$e_n$	Input Noise Voltage Density	$f = 1kHz$		45		$nV/\sqrt{Hz}$
$i_n$	Input Noise Current Density	$f = 1kHz$		0.05		$pA/\sqrt{Hz}$
$A_{VOL}$	Large-Signal Voltage Gain	$V_S = 5V$ , $V_O = 0.5V$ to $4.4V$ , $R_L = 10k$	400	1500		V/mV
		$V_S = 3V$ , $V_O = 0.5V$ to $2.4V$ , $R_L = 10k$	250	1000		V/mV

## ELECTRICAL CHARACTERISTICS

$T_A = 25^\circ\text{C}$ ,  $V_S = 5\text{V}$ ,  $0\text{V}$ ;  $V_S = 3\text{V}$ ,  $0\text{V}$ ;  $V_{CM} = V_O = \text{half supply}$ , unless otherwise noted.

SYMBOL	PARAMETER	CONDITIONS	MIN	TYP	MAX	UNITS
CMRR	Common Mode Rejection Ratio CMRR Match (Channel-to-Channel)	$V_{CM} = V^- \text{ to } V^+$ , $V_S = 5\text{V}$	83	96		dB
		$V_{CM} = V^- \text{ to } V^+$ , $V_S = 5\text{V}$ (Note 4)	80	93		dB
PSRR	Power Supply Rejection Ratio PSRR Match (Channel-to-Channel)	$V_S = 2.3\text{V to } 12\text{V}$ , $V_{CM} = V_O = 0.5\text{V}$	90	105		dB
		$V_S = 2.3\text{V to } 12\text{V}$ , $V_{CM} = V_O = 0.5\text{V}$ (Note 4)	84	105		dB
$V_{OL}$	Output Voltage Swing LOW	No Load		32	60	mV
		$I_{SINK} = 0.5\text{mA}$		135	270	mV
		$I_{SINK} = 2.5\text{mA}$		235	470	mV
$V_{OH}$	Output Voltage Swing HIGH	No Load	$V^+ - 0.052$	$V^+ - 0.026$		V
		$I_{SOURCE} = 0.5\text{mA}$	$V^+ - 0.270$	$V^+ - 0.135$		V
		$I_{SOURCE} = 2.5\text{mA}$	$V^+ - 0.570$	$V^+ - 0.265$		V
$I_{SC}$	Short-Circuit Current		10	17		mA
$I_S$	Supply Current per Amplifier			60	75	$\mu\text{A}$

$0^\circ\text{C} \leq T_A \leq 70^\circ\text{C}$ ,  $V_S = 5\text{V}$ ,  $0\text{V}$ ;  $V_S = 3\text{V}$ ,  $0\text{V}$ ;  $V_{CM} = V_O = \text{half supply}$ , unless otherwise noted.

SYMBOL	PARAMETER	CONDITIONS	MIN	TYP	MAX	UNITS
$V_{OS}$	Input Offset Voltage	$V_{CM} = V^+$	●	140	585	$\mu\text{V}$
		$V_{CM} = V^-$	●	140	585	$\mu\text{V}$
$V_{OS\ TC}$	Input Offset Voltage Drift (Note 2)		●	2	7	$\mu\text{V}/^\circ\text{C}$
$\Delta V_{OS}$	Input Offset Voltage Shift	$V_{CM} = V^- \text{ to } V^+$	●	80	500	$\mu\text{V}$
	Input Offset Voltage Match (Channel-to-Channel)	$V_{CM} = V^-, V^+$ (Notes 3, 4)	●	170	825	$\mu\text{V}$
$I_B$	Input Bias Current	$V_{CM} = V^+$	●	8	16	nA
		$V_{CM} = V^-$	●	-16	-8	nA
$\Delta I_B$	Input Bias Current Shift	$V_{CM} = V^- \text{ to } V^+$	●	16	32	nA
$I_{OS}$	Input Offset Current	$V_{CM} = V^+$	●	0.7	5.3	nA
		$V_{CM} = V^-$	●	0.5	5.3	nA
$\Delta I_{OS}$	Input Offset Current Shift	$V_{CM} = V^- \text{ to } V^+$	●	0.8	7.5	nA
	Input Bias Current Match (Channel-to-Channel)	$V_{CM} = V^+$ (Note 4) $V_{CM} = V^-$ (Note 4)	● ●	0.7 0.6	7.5 7.5	nA nA
$A_{VOL}$	Large-Signal Voltage Gain	$V_S = 5\text{V}$ , $V_O = 0.5\text{V to } 4.4\text{V}$ , $R_L = 10\text{k}$	●	100	500	V/mV
		$V_S = 3\text{V}$ , $V_O = 0.5\text{V to } 2.4\text{V}$ , $R_L = 10\text{k}$	●	70	400	V/mV
CMRR	Common Mode Rejection Ratio CMRR Match (Channel-to-Channel)	$V_{CM} = V^- \text{ to } V^+$ , $V_S = 5\text{V}$	●	80	96	dB
		$V_{CM} = V^- \text{ to } V^+$ , $V_S = 5\text{V}$ (Note 4)	●	75	93	dB
PSRR	Power Supply Rejection Ratio PSRR Match (Channel-to-Channel)	$V_S = 2.3\text{V to } 12\text{V}$ , $V_{CM} = V_O = 0.5\text{V}$	●	80	105	dB
		$V_S = 2.3\text{V to } 12\text{V}$ , $V_{CM} = V_O = 0.5\text{V}$ (Note 4)	●	80	105	dB
$V_{OL}$	Output Voltage Swing LOW	No Load	●	42	80	mV
		$I_{SINK} = 0.5\text{mA}$	●	150	300	mV
		$I_{SINK} = 2.5\text{mA}$	●	270	540	mV
$V_{OH}$	Output Voltage Swing HIGH	No Load	●	$V^+ - 0.065$	$V^+ - 0.033$	V
		$I_{SOURCE} = 0.5\text{mA}$	●	$V^+ - 0.305$	$V^+ - 0.155$	V
		$I_{SOURCE} = 2.5\text{mA}$	●	$V^+ - 0.620$	$V^+ - 0.310$	V
$I_{SC}$	Short-Circuit Current		7	16		mA
$I_S$	Supply Current per Amplifier			70	85	$\mu\text{A}$

## ELECTRICAL CHARACTERISTICS

$T_A = 25^\circ\text{C}$ ,  $V_S = \pm 5\text{V}$ ,  $V_{CM} = V_O = 0\text{V}$ , unless otherwise noted.

SYMBOL	PARAMETER	CONDITIONS	MIN	TYP	MAX	UNITS
$V_{OS}$	Input Offset Voltage	$V_{CM} = V^+$		120	475	$\mu\text{V}$
		$V_{CM} = V^-$		120	475	$\mu\text{V}$
$\Delta V_{OS}$	Input Offset Voltage Shift	$V_{CM} = V^-$ to $V^+$		80	390	$\mu\text{V}$
	Input Offset Voltage Match (Channel-to-Channel)	$V_{CM} = V^-, V^+$ (Notes 3, 4)		150	685	$\mu\text{V}$
$I_B$	Input Bias Current	$V_{CM} = V^+$		3	14	nA
		$V_{CM} = V^-$	-14	-6		nA
$\Delta I_B$	Input Bias Current Shift	$V_{CM} = V^-$ to $V^+$		9	28	nA
$I_{OS}$	Input Offset Current	$V_{CM} = V^+$		0.6	3.6	nA
		$V_{CM} = V^-$		0.4	3.6	nA
$\Delta I_{OS}$	Input Offset Current Shift	$V_{CM} = V^-$ to $V^+$		0.9	5.1	nA
		Input Bias Current Match (Channel-to-Channel)	$V_{CM} = V^+$ (Note 4) $V_{CM} = V^-$ (Note 4)		0.6 0.6	5.1 5.1
$A_{VOL}$	Large-Signal Voltage Gain	$V_O = \pm 4.25\text{V}$ , $R_L = 10\text{k}$	250	450		V/mV
		Channel Separation	$V_O = \pm 4.25\text{V}$ , $R_L = 10\text{k}$	120	130	
SR	Slew Rate	$A_V = -1$ , $R_L = \infty$	0.018	0.04		V/ $\mu\text{s}$
CMRR	Common Mode Rejection Ratio CMRR Match (Channel-to-Channel)	$V_{CM} = V^-$ to $V^+$	88	102		dB
		$V_{CM} = V^-$ to $V^+$ (Note 4)	82	99		dB
$V_{OL}$	Output Voltage Swing LOW	No Load		$V^- + 0.032$	$V^- + 0.060$	V
		$I_{SINK} = 0.5\text{mA}$		$V^- + 0.135$	$V^- + 0.270$	V
		$I_{SINK} = 2.5\text{mA}$		$V^- + 0.235$	$V^- + 0.470$	V
$V_{OH}$	Output Voltage Swing HIGH	No Load	$V^+ - 0.052$	$V^+ - 0.026$		V
		$I_{SOURCE} = 0.5\text{mA}$	$V^+ - 0.270$	$V^+ - 0.135$		V
		$I_{SOURCE} = 2.5\text{mA}$	$V^+ - 0.570$	$V^+ - 0.265$		V
$I_{SC}$	Short-Circuit Current		10	18		mA
$I_S$	Supply Current per Amplifier			70	80	$\mu\text{A}$
GBW	Gain Bandwidth Product	$f = 1\text{kHz}$		120		kHz

$0^\circ\text{C} \leq T_A \leq 70^\circ\text{C}$ ,  $V_S = \pm 5\text{V}$ ,  $V_{CM} = V_O = 0\text{V}$ , unless otherwise noted.

SYMBOL	PARAMETER	CONDITIONS	MIN	TYP	MAX	UNITS
$V_{OS}$	Input Offset Voltage	$V_{CM} = V^+$	●	150	660	$\mu\text{V}$
		$V_{CM} = V^-$	●	150	660	$\mu\text{V}$
$\Delta V_{OS}$	Input Offset Voltage Shift	$V_{CM} = V^-$ to $V^+$	●	90	500	$\mu\text{V}$
		Input Offset Voltage Match (Channel-to-Channel)	$V_{CM} = V^-, V^+$ (Notes 3, 4)	●	180	900
$I_B$	Input Bias Current	$V_{CM} = V^+$	●	8	16	nA
		$V_{CM} = V^-$	●	-16	-8	nA
$\Delta I_B$	Input Bias Current Shift	$V_{CM} = V^-$ to $V^+$	●	16	32	nA
$I_{OS}$	Input Offset Current	$V_{CM} = V^+$	●	0.8	5.3	nA
		$V_{CM} = V^-$	●	0.6	5.3	nA
$\Delta I_{OS}$	Input Offset Current Shift	$V_{CM} = V^-$ to $V^+$	●	0.9	7.5	nA
		Input Bias Current Match (Channel-to-Channel)	$V_{CM} = V^+$ (Note 4) $V_{CM} = V^-$ (Note 4)	● ●	0.7 0.6	7.5 7.5
$A_{VOL}$	Large-Signal Voltage Gain	$V_O = \pm 4.25\text{V}$ , $R_L = 10\text{k}$	●	100	250	V/mV
		Channel Separation	$V_O = \pm 4.25\text{V}$ , $R_L = 10\text{k}$	●	120	130
CMRR	Common Mode Rejection Ratio CMRR Match (Channel-to-Channel)	$V_{CM} = V^-$ to $V^+$	●	86	101	dB
		$V_{CM} = V^-$ to $V^+$ (Note 4)	●	80	98	dB

# ELECTRICAL CHARACTERISTICS

0°C ≤ T<sub>A</sub> ≤ 70°C, V<sub>S</sub> = ±5V, V<sub>CM</sub> = V<sub>O</sub> = 0V, unless otherwise noted.

SYMBOL	PARAMETER	CONDITIONS	MIN	TYP	MAX	UNITS
V <sub>OL</sub>	Output Voltage Swing LOW	No Load	●	V <sup>-</sup> + 0.042	V <sup>-</sup> + 0.080	V
		I <sub>SINK</sub> = 0.5mA	●	V <sup>-</sup> + 0.150	V <sup>-</sup> + 0.300	V
		I <sub>SINK</sub> = 2.5mA	●	V <sup>-</sup> + 0.270	V <sup>-</sup> + 0.540	V
V <sub>OH</sub>	Output Voltage Swing HIGH	No Load	●	V <sup>+</sup> - 0.065	V <sup>+</sup> - 0.033	V
		I <sub>SOURCE</sub> = 0.5mA	●	V <sup>+</sup> - 0.305	V <sup>+</sup> - 0.155	V
		I <sub>SOURCE</sub> = 2.5mA	●	V <sup>+</sup> - 0.620	V <sup>+</sup> - 0.310	V
I <sub>SC</sub>	Short-Circuit Current		●	7	18	mA
I <sub>S</sub>	Supply Current per Amplifier		●	70	90	μA

The ● denotes specifications which apply over the full operating temperature range.

**Note 1:** A heat sink may be required to keep the junction temperature below the Absolute Maximum Rating when the output is shorted indefinitely.

**Note 2:** This parameter is not 100% tested.

**Note 3:** Input offset match is the difference in offset voltage between amplifiers measured at both V<sub>CM</sub> = V<sup>-</sup> and V<sub>CM</sub> = V<sup>+</sup>.

**Note 4:** Matching parameters are the difference between amplifiers A and D and between B and C.

# TYPICAL PERFORMANCE CHARACTERISTICS

V<sub>OS</sub> Distribution, V<sub>CM</sub> = 0V

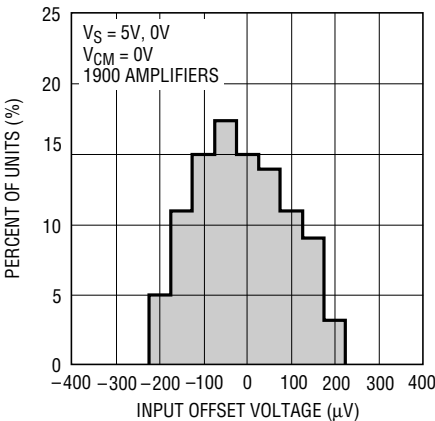

1466L/67L G01

V<sub>OS</sub> Distribution, V<sub>CM</sub> = 5V

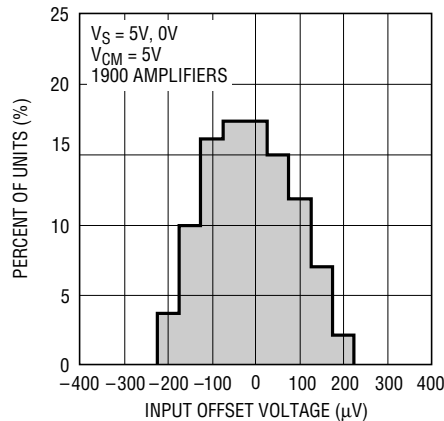

1466L/67L G02

V<sub>OS</sub> Shift, V<sub>CM</sub> = 0V to 5V

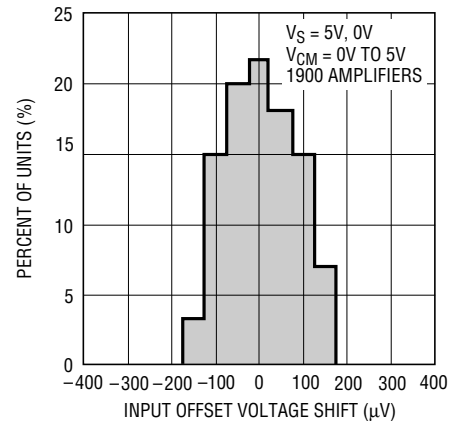

1466L/67L G03

TYPICAL PERFORMANCE CHARACTERISTICS

Supply Current vs Temperature

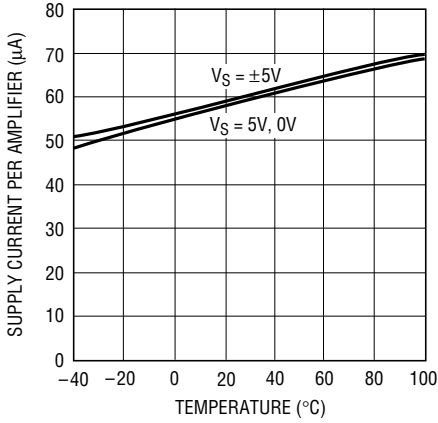

1466L/67L G04

Minimum Supply Voltage

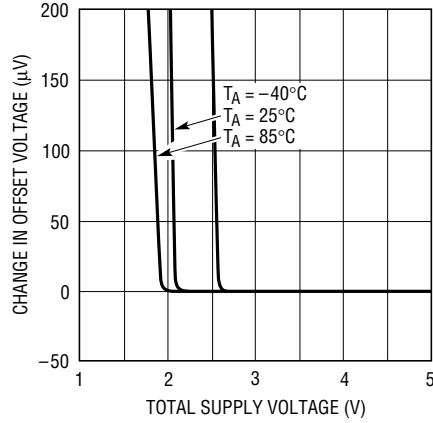

1466L/67L G05

Input Bias Current vs Common Mode Voltage

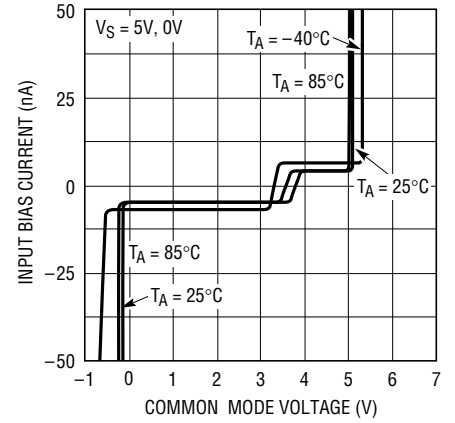

1466L/67L G06

Output Saturation Voltage vs Load Current (Output Low)

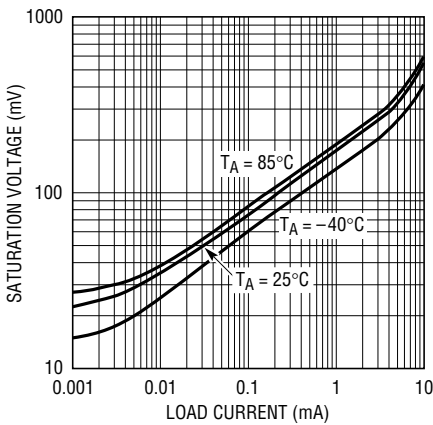

1466L/67L G07

Output Saturation Voltage vs Load Current (Output High)

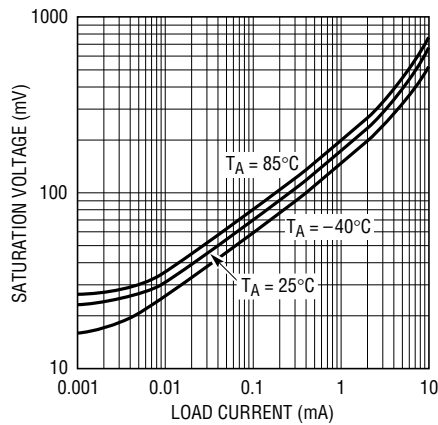

1466L/67L G08

0.1Hz to 10Hz Output Voltage Noise

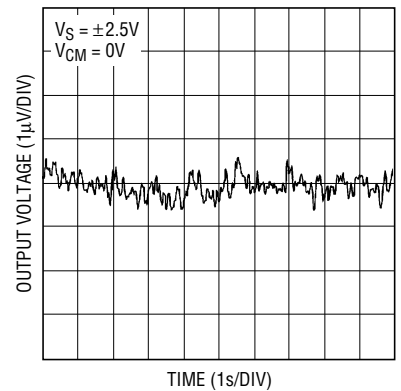

1466L/67L G09

Voltage Noise Spectrum

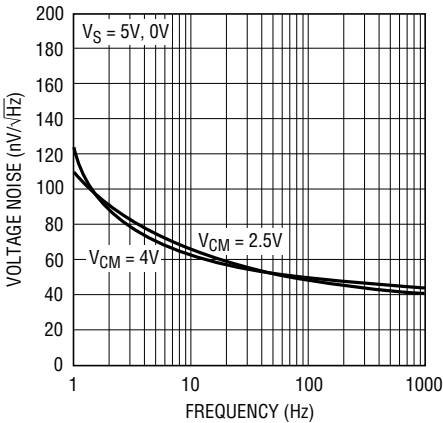

1466L/67L G10

Current Noise Spectrum

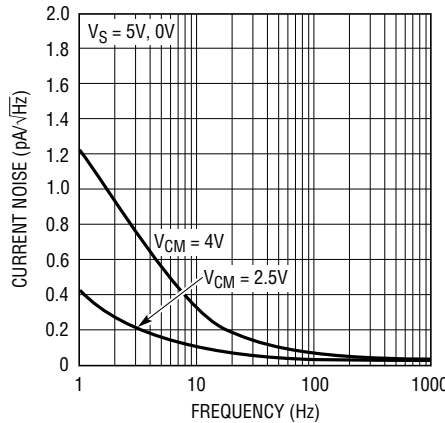

1466L/67L G11

Gain and Phase Shift vs Frequency

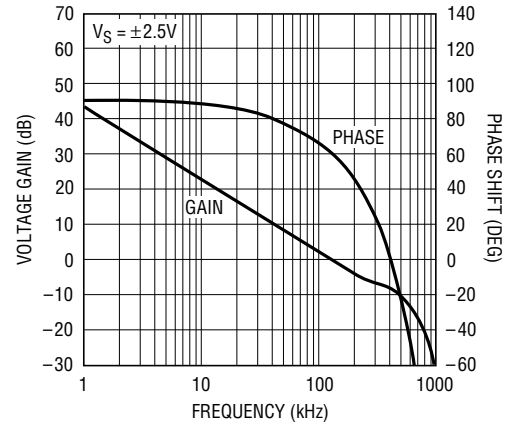

1466L/67L G12

# TYPICAL PERFORMANCE CHARACTERISTICS

**Gain Bandwidth and Phase Margin vs Supply Voltage**

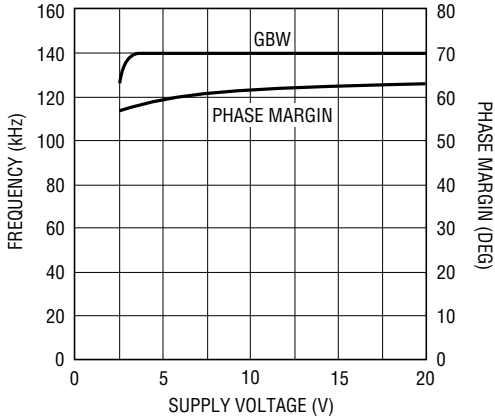

1466L/67L G13

**Common Mode Rejection Ratio vs Frequency**

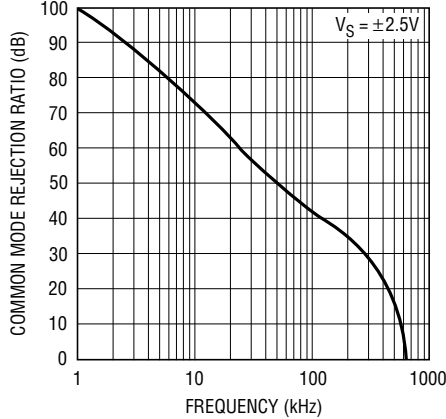

1466L/67L G14

**Power Supply Rejection Ratio vs Frequency**

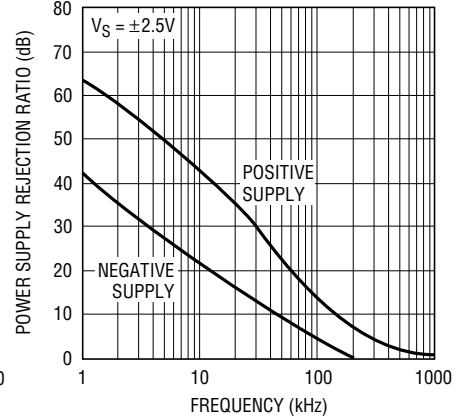

1466L/67L G15

**Closed-Loop Output Impedance vs Frequency**

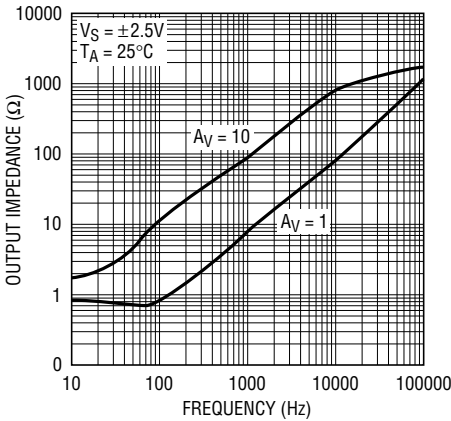

1466L/67 G16

**Capacitive Load Handling**

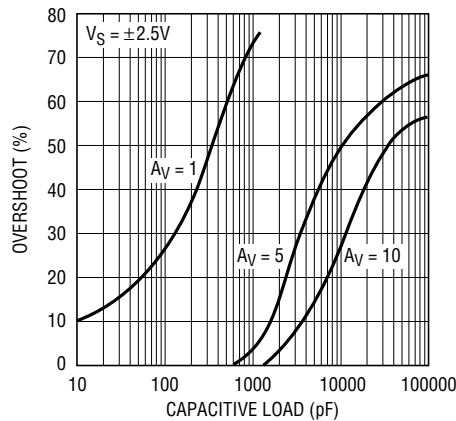

1466L/67L G17

**Voltage Gain, VS = ±5V**

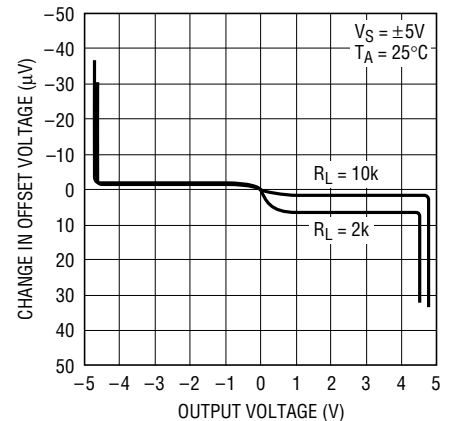

1466L/67L G18

**Voltage Gain, VS = 5V, 0V**

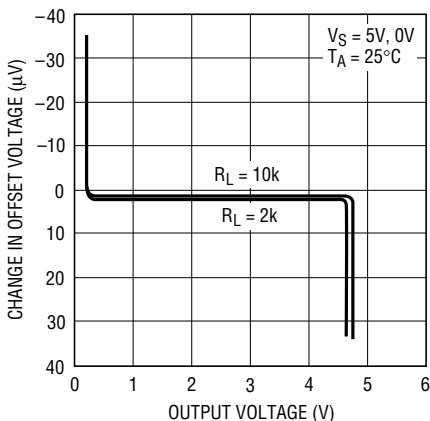

1466L/67L G19

**Input Offset Drift vs Time**

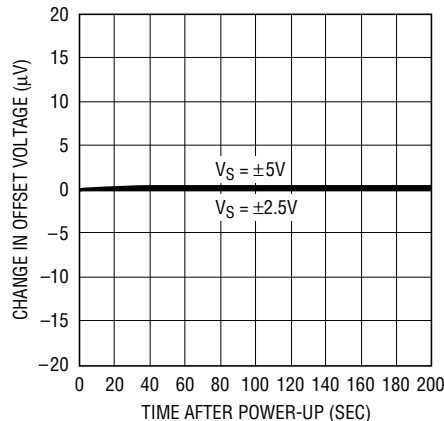

1466L/67L G20

**Output Saturation Voltage vs Input Overdrive**

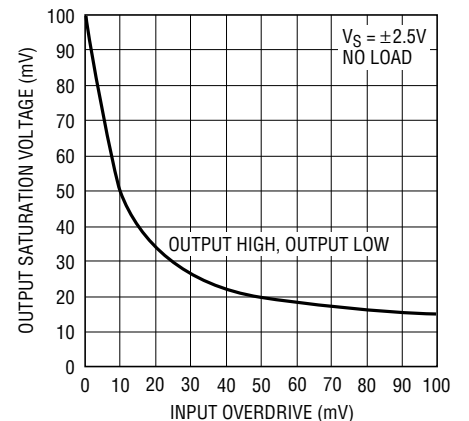

1466L/67L G21

## TYPICAL PERFORMANCE CHARACTERISTICS

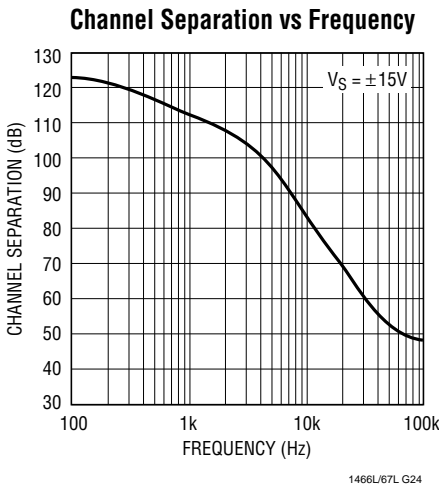

**Small-Signal Response**  
 $V_S = \pm 2.5V$

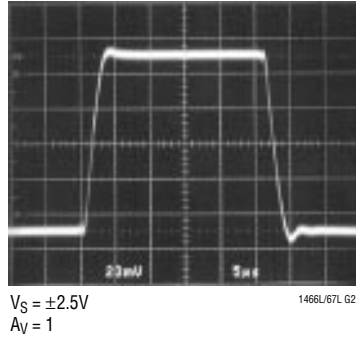

**Large-Signal Response**  
 $V_S = \pm 5V$

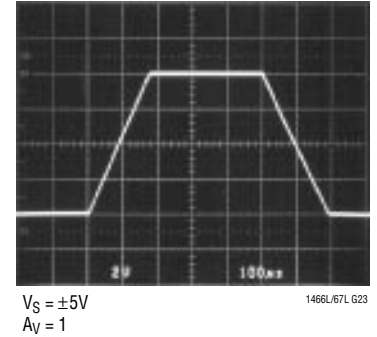

## APPLICATIONS INFORMATION

### Rail-to-Rail Operation

The LT1466L/LT1467L differ from conventional op amps in the design of both the input and output stages. Figure 1 shows a simplified schematic. The input stage consists of two differential amplifiers, a PNP stage Q1-Q2 and an NPN stage Q3-Q4, that are active over different portions of the input common mode range. Each input stage is trimmed for offset voltage. A complementary output configuration (Q12-Q13) is employed to create an output stage with rail-to-rail swing. The devices are fabricated on Linear

Technology's proprietary complementary bipolar process, which ensures very similar DC and AC characteristics for the output devices Q12 and Q13.

First, looking at the input stage, Q5 switches the current from current source  $I_1$  between the two input stages. When the input common mode voltage  $V_{CM}$  is near the negative supply, Q5 is reverse biased, so the current from  $I_1$  becomes the tail current for the PNP differential pair Q1-Q2. At the other extreme, when  $V_{CM}$  is near the positive supply, the PNPs Q1-Q2 are biased off. The current from

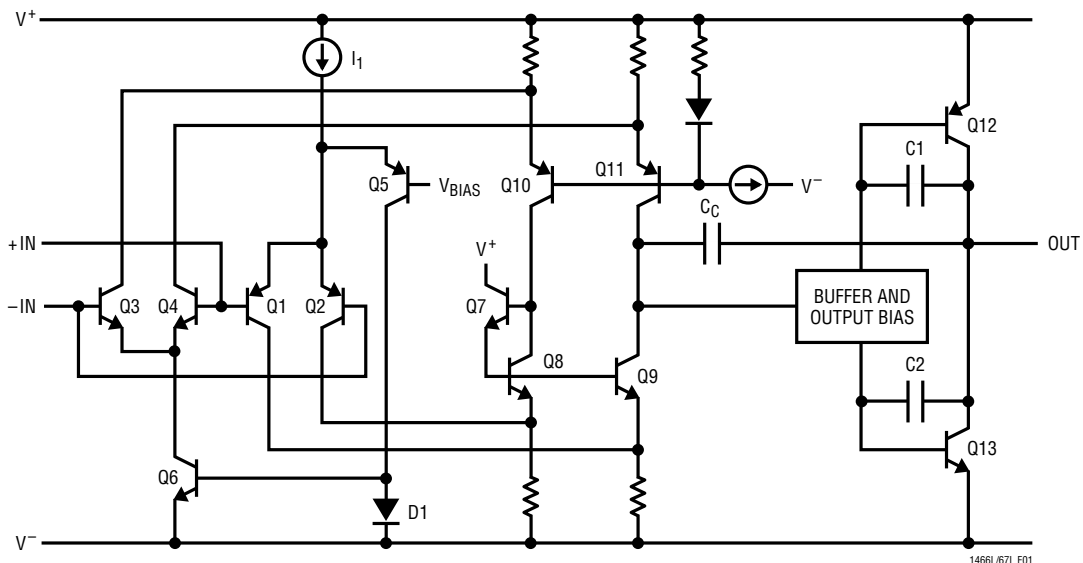

Figure 1. Simplified Schematic



## APPLICATIONS INFORMATION

$I_1$  then flows through Q5 to the current mirror D3-Q6, furnishing the tail current for the NPN differential pair Q3-Q4. The switchover point between stages occurs when  $V_{CM}$  is equal to the base voltage of Q5, which is biased approximately 1.3V below the positive supply.

The collector currents of the two input pairs are combined in the second stage, consisting of Q7-Q11. Most of the voltage gain in the amplifier is contained in this stage. The output of the second stage is buffered and applied to the output devices Q12 and Q13. Capacitors C1 and C2 form local feedback loops around the output devices, lowering the output impedance at high frequencies. Capacitor  $C_C$  sets the amplifier bandwidth.

### Input Offset Voltage

Since the amplifier has two input stages, the input offset voltage changes depending upon which stage is active. When the amplifier switches between stages, the offset voltage may go up, down or remain flat. Both stages of the LT1466L/LT1467L are trimmed; one at the negative sup-

ply and the other at the positive supply. The resulting common mode rejection ratio of 83dB minimum is much better than typical rail-to-rail amplifiers.

### Overdrive Protection

The LT1466L/LT1467L contain circuits that prevent the output from reversing polarity when the input voltage exceeds either supply. For these circuits to work properly, the input current should be limited to  $-10\text{mA}$  when the input is below the negative supply, and  $0.5\text{mA}$  when the input is above the positive supply. If the amplifier is to be severely overdriven, an external resistor should be used to limit the current.

### Output

The output voltage swing and current sinking capability of the LT1466L/LT1467L are affected by input overdrive as shown in the Typical Performance Characteristics. When monitoring voltages within 100mV of either rail, gain should be taken to keep the output from clipping.

**PACKAGE DESCRIPTION** Dimensions in inches (millimeters) unless otherwise noted.

**N8 Package**  
**8-Lead PDIP (Narrow 0.300)**  
 (LTC DWG # 05-08-1510)

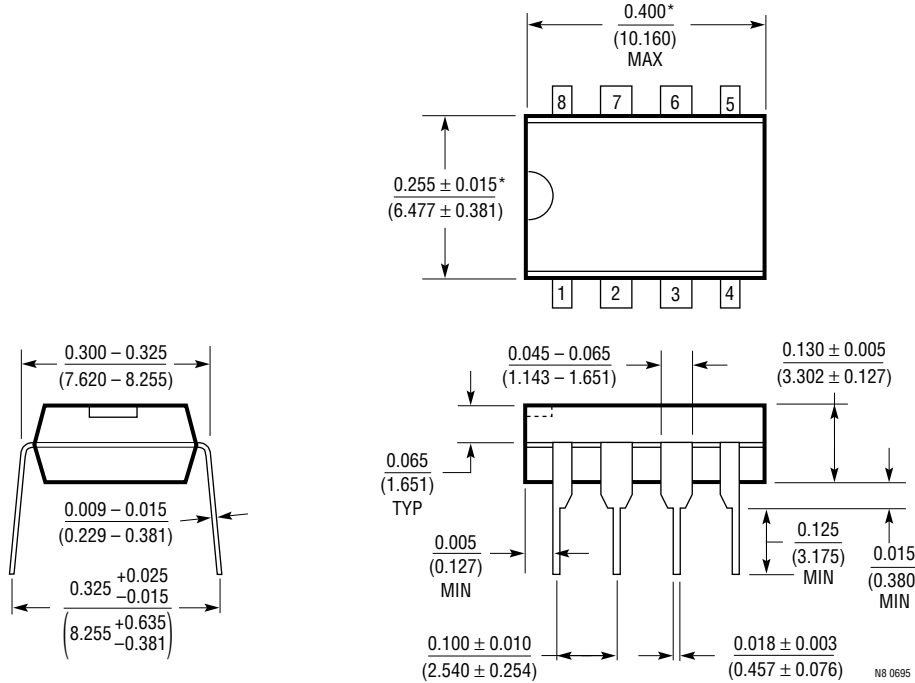

\*THESE DIMENSIONS DO NOT INCLUDE MOLD FLASH OR PROTRUSIONS.  
 MOLD FLASH OR PROTRUSIONS SHALL NOT EXCEED 0.010 INCH (0.254mm)

**S8 Package**  
**8-Lead Plastic Small Outline (Narrow 0.150)**  
 (LTC DWG # 05-08-1610)

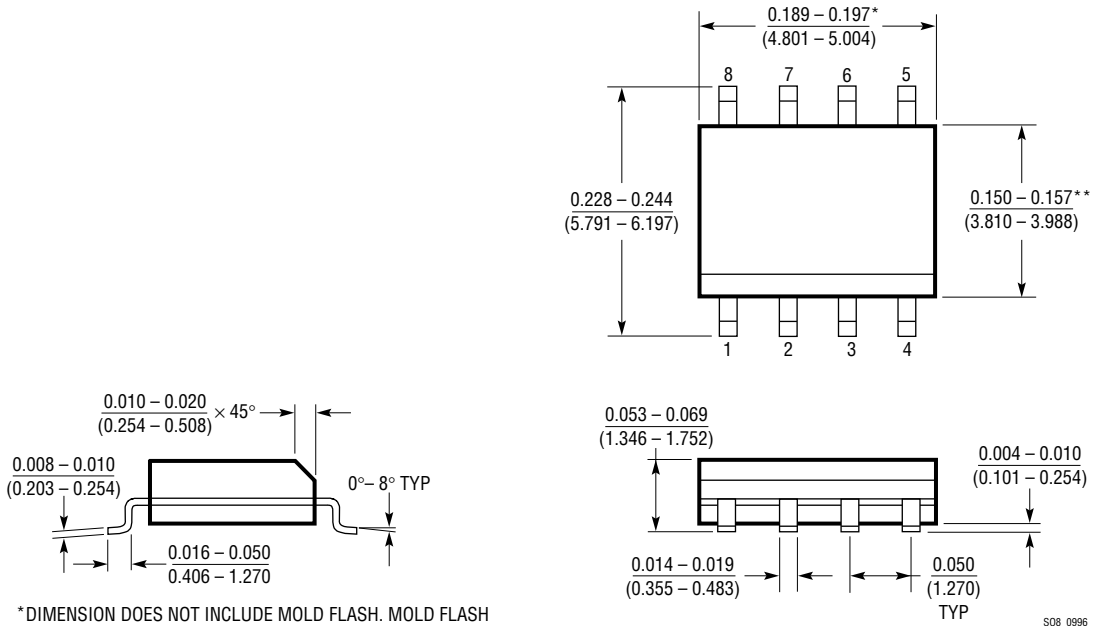

\*DIMENSION DOES NOT INCLUDE MOLD FLASH. MOLD FLASH SHALL NOT EXCEED 0.006" (0.152mm) PER SIDE  
 \*\*DIMENSION DOES NOT INCLUDE INTERLEAD FLASH. INTERLEAD FLASH SHALL NOT EXCEED 0.010" (0.254mm) PER SIDE

**PACKAGE DESCRIPTION** Dimensions in inches (millimeters) unless otherwise noted.

**S Package**  
**16-Lead Plastic Small Outline (Narrow 0.150)**  
 (LTC DWG # 05-08-1610)

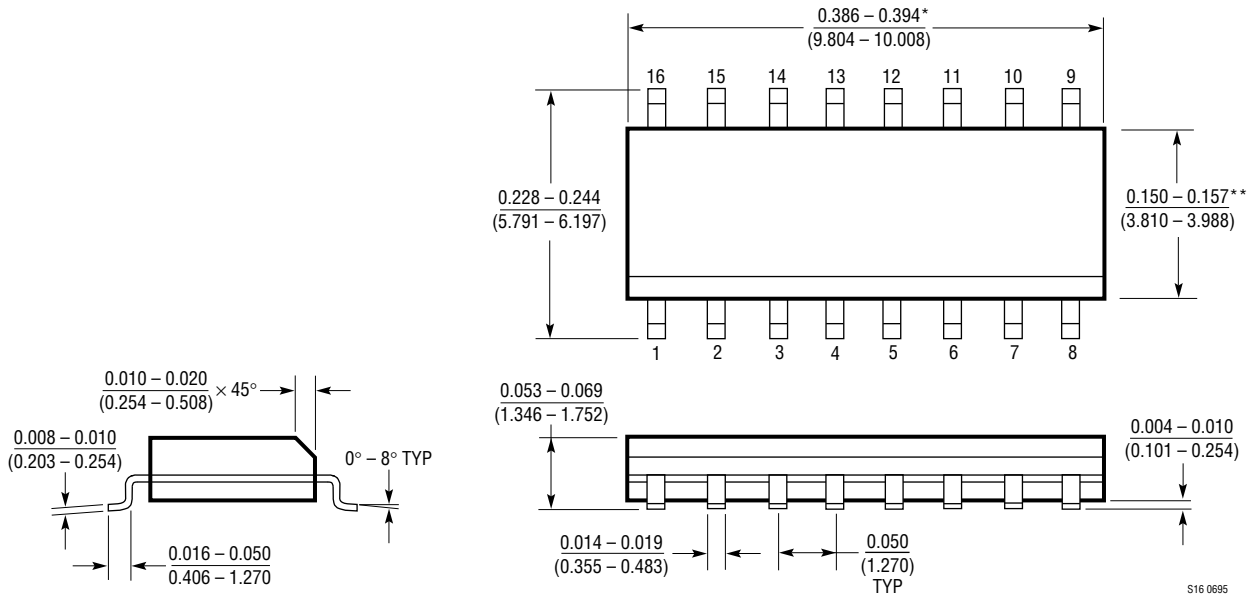

\*DIMENSION DOES NOT INCLUDE MOLD FLASH. MOLD FLASH SHALL NOT EXCEED 0.006" (0.152mm) PER SIDE  
 \*\*DIMENSION DOES NOT INCLUDE INTERLEAD FLASH. INTERLEAD FLASH SHALL NOT EXCEED 0.010" (0.254mm) PER SIDE

S16 0695

## TYPICAL APPLICATIONS

### 4-Pole, 1kHz, 3.3V Single Supply State Variable Filter Using the LT1467L

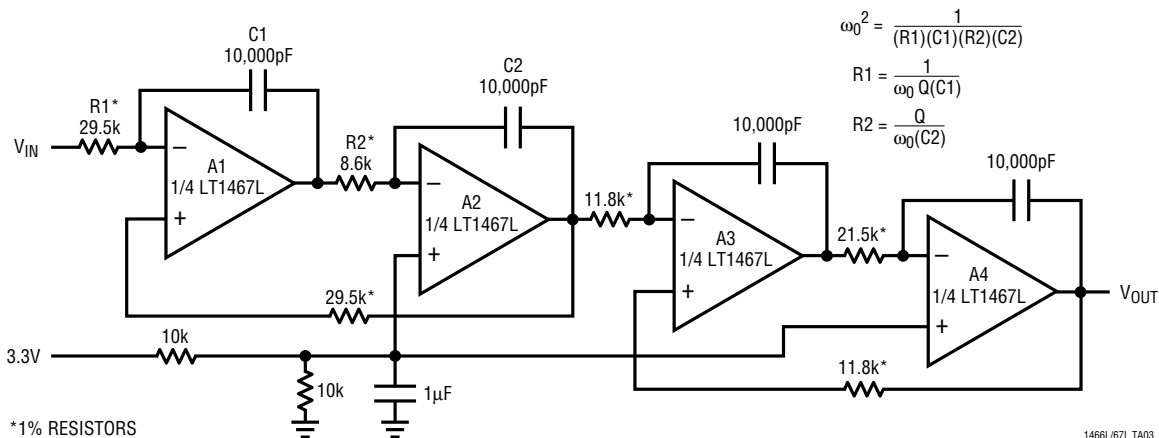

### Frequency Response of 4th Order Butterworth Filter

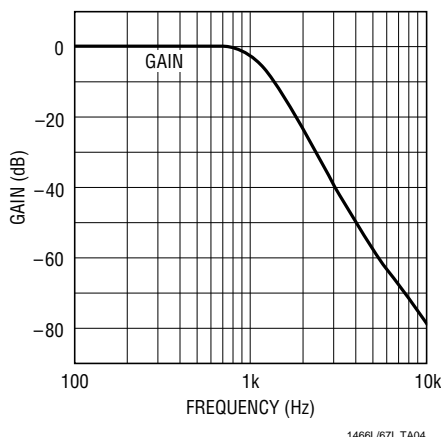

## RELATED PARTS

PART NUMBER	DESCRIPTION	COMMENTS
LTC®1152	Rail-to-Rail Input and Output, Zero-Drift Op Amp	High DC Accuracy, 10μV V <sub>OS(MAX)</sub> , 100nV/°C Drift, 0.7MHz GBW, 0.5V/μs Slew Rate, Maximum Supply Current 3mA
LT1366/LT1367	Dual/Quad Precision, Rail-to-Rail Input and Output Op Amps	475μV V <sub>OS(MAX)</sub> , 400kHz GBW, 0.13V/μs Slew Rate, Maximum Supply Current 520μA per Op Amp
LT1498 /LT1499	Dual/Quad, 10MHz Rail-to-Rail Input and Output Op Amps	High Speed, 5V/μs Slew Rate, 475μV V <sub>OS(MAX)</sub> from V <sup>+</sup> to V <sup>-</sup> , Max Supply Current 2.2mA per Op Amp